



ECHONET

**Energy Conservation
and Homecare Network**

ECHONET Consortium

Greeting



**Representative Director
Takeshi Saito, TOSHIBA Corporation**

ECHONET Consortium was established in 1997 with the aim of creating an abundant 21st-century society where people and the environment live in harmony. ECHONET Consortium marked its 20th anniversary in 2017 and celebrated its 25th anniversary in December 2022, thanks to your kind efforts and cooperation.

Meanwhile, ECHONET Consortium has promoted the establishment of standard specifications for a home network infrastructure that is capable of interconnecting home appliances, facility devices, sensors, and controllers supplied by multiple vendors and a basic technology such as network for small and medium-sized buildings and stores, to cope with environmental issues, energy problems, CO2 emission reductions, and an aging society.

Since the "ECHONET Lite standards" announced in 2011 is a domestic and foreign standard protocol, it was recommended as a known standard interface in HEMS (Home Energy Management System) at the "Smart Community Alliance International Standardization WG Standardization Study Group" the following year and was approved as an international standard in 2015. After that, we formulated the "AIF specifications" with the aim of improving full-scale interoperability between multi-vendors and started the certification system in 2016. Thanks to the efforts of our members the number of ECHONET Lite devices shipped has reached more than 138 million units centered on the eight priority devices (air conditioner, storage battery, water heater, solar power generator, fuel cell, lighting equipment, smart meter, charger/discharger for electric vehicles) and the number of device objects has reached 120 models as of the end of FY2022.

Its coverage is expanding more and more. In recent years, we face a number of enormous challenges such as "Corona disaster and new normal", "Global conflict and accompanying economic/energy security", and "Frequent catastrophic disaster", and those considered to be the causes of them such as "Global warming", "Low birthrate", "aging" and "healthcare."

On the other hand, in order to contribute to these solutions, many ideas such as "Birth of Digital Agency", "The Vision for a Digital Garden City Nation", "Smart Home", "Carbon Neutral", and "Next Generation Smart Meter" have been proposed. Together with bold digitization measures and data utilization, these are also areas where ECHONET Consortium can make significant contributions by monitoring and controlling of housing equipment and industrial equipment and encouraging changes in user behavior.

In addition to these, we will promote activities to realize the SDGs by ECHONET 2.0 aiming at the realization of "Orderly collaborative creation space" that is the base of the expansion of ECHONET Lite to the Web space and service alignment. We ask for the support and cooperation of all concerned parties.

Managing director:	Hisashi Kodama	
Director:	Nobuo Asahi	Mitsubishi Electric Corporation
	Takayuki Amatsu	Tokyo Electric Power Holdings, Inc.
	Hironori Nakata	Sharp Corporation
	Katsuhiko Hiramatsu	Panasonic Corporation
Auditor:	Nobuhiko Hatta	Lawyer

Changes in the environment surrounding smart home

After reaching a peak in FY2004, the energy consumption in Japan has been on a downward trend. This is due to economic growth while curbing energy consumption as Japanese energy consumption moves towards energy saving, particularly in the industry sector, and the development of energy saving products has become popular.

However, when looking at trends by sector for growth between FY1973 (at the time of the oil embargo) and FY2020, while the commercial and business sector remained at 0.9 times with the progress in energy saving mainly in the manufacturing industry, as a result of the 1.9 times increase in energy consumption in the household sector, its share against the total consumption has changed from 8.9% to 15.8%.

In response to the tight power supply and instability of energy prices, there is a renewed sense of the importance of energy conservation in the household sector and it is essential to improve the energy conservation of houses themselves.

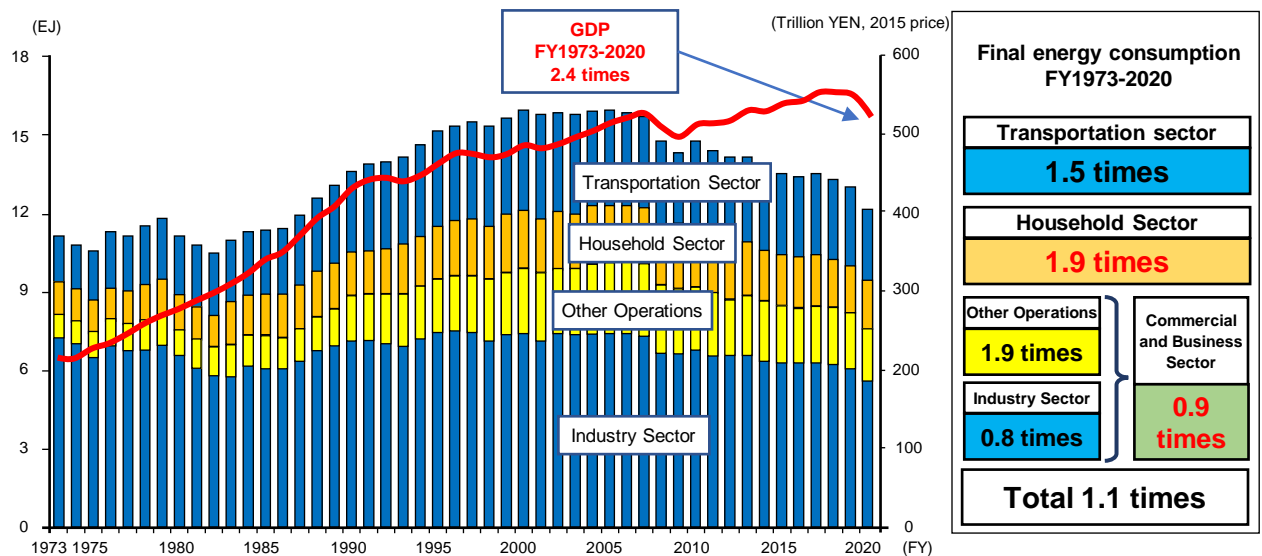

Source: Ministry of Economy, Trade and Industry / Agency for Natural Resources and Energy--Japan's Energy White Paper 2022

On the other hand, thanks to a policy established to promote the introduction of solar power generation, it has increased by an average of approximately 64 MW a month since 2013 and is forecast to reach approximately 140 GW by 2030. The result of this may cause that the generated power has exceeded demand from business offices and homes is flowing into the power distribution system and as this has caused a rise in voltage in the power distribution system, it has the potential to interrupt the high quality and stable provision of power. In order to prevent this, in addition to promoting technical development that would restrain the amount of power generated by solar power generation, there are calls for promoting the deployment of equipment that can store energy, such as electric vehicles, storage batteries and heat pump water heaters, thus “creating electricity”, “storing electricity” and “efficiently using electricity”.

Under these circumstances, Net Zero Energy Houses (ZEH) are attracting wider attention as a housing solution that minimizes energy consumption in houses and energy independence in cases of disaster. A ZEH is “a house that aims to achieve a zero balance of annual primary energy consumption through the introduction of renewable energies, after drastically improving heat insulation performance in its outer shell and achieving substantial energy conservation, while maintaining room environment quality by introducing highly effective equipment systems”. The increasing spread of ZEH is expected to drastically improve the energy supply and demand structure. In Japan, the policy target is set to “aiming to achieve ZEH for average new houses by 2030” and the Sixth Strategic Energy Plan (approved by the Cabinet in October 2021) states the further energy-saving measures will be comprehensively promoted for the realization of carbon neutrality by 2050 and the GHG emission reduction by 2030.

Further, there is a duty to deploy smart meters in all households. All power companies began in July 2015 to complete deployment in all houses by 2025. This smart meter uses a means of transmitting information known as “route B”, which adopted the ECHONET Lite Standards. With this adaptation as a trigger, equipment which adopts the ECHONET Lite Standards becomes widespread in the home, which makes the electricity usage status measured by the smart meter can be observed in the home as well.

The cumulative number of ECHONET Lite devices excluding smart meters shipped from FY2013 to FY2022 reached 59.22 million units. On the other hand, the cumulative number of installed smart meters by FY2021 and planned smart meters to be installed in FY2022 reached 79.57 million units.

Therefore, the total number of ECHONET Lite compliant products by FY2022 reached 138.8 million units.

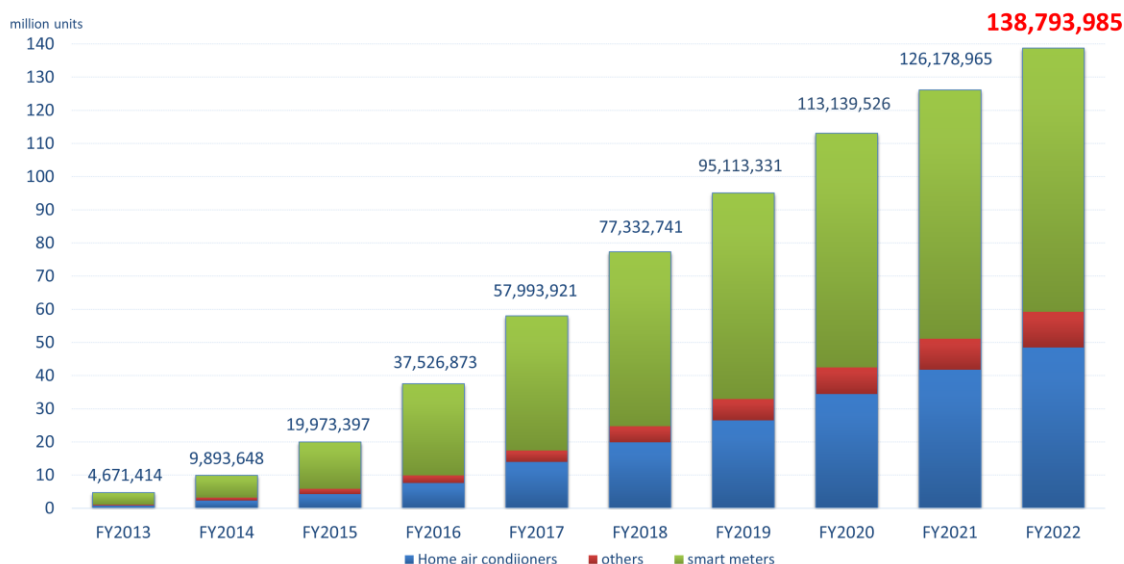

Cumulative number of shipped or scheduled ECHONET Lite compliant devices

In countries other than Japan, “ECHONET Lite Communication Middleware” and “Detailed Requirements for ECHONET Device objects”, which both make up a major part of the ECHONET Lite standards, were approved as international standards as ISO/IEC 14543-4-3 and IEC62394 in 2015. ECHONET Lite research and development centers and regional bases have begun operation in ASEAN countries, such as Malaysia and Thailand in 2016.

In 2020, an international standard related to “Interface Specifications for Application Layer Communication between home air conditioners and controllers” proposed by Japan was approved by the ISO/IEC Joint Technical Committee (JTC 1) and published. Following this international standard, a draft international standard for the AIF specifications for the household devices capable of supplying energy such as storage battery is currently being studied. This means that a process to build an environment to spread HEMS devices in terms of both using and storing electricity is underway, and we can expect not only reduced energy consumption through HEMS, but also the promotion of using various types of energy at home (a combination of using renewable energy, stored energy, and energy generation equipment). If the introduction of HEMS on a global scale progress, we can also expect HEMS related Japanese products such as air conditioners have a greater advantage, along with an expanded market for service businesses related to them.

On the other hand, in the field of information technology, the IoT (Internet of Things) has been proposed and a new value that leverages the vast amount of interconnected and collected data via internet has been created. Moreover, in the future society to be realized under Society 5.0 which is advocated as the ideal form of Japan, social issues are resolved, and new value is brought by linking all people and things through IoT, sharing a wide variety of knowledge and information, creating completely new value, and creating opportunities to provide the timely and necessary information when using artificial intelligence (AI).

The ECHONET Consortium promotes ECHONET 2.0 with setting healthcare as the second key service in addition to conventional energy management to help realize an IoT society, Society 5.0 and SDGs. The ECHONET Consortium expands the scope of study to a system including online services and promotes “sorting out the concepts of system reliability” and “technical investigations into the linkages between servers”, and also works on “improvement of the developing environment for newcomers”.

ECHONET Lite, a publicly-known standard that realizes smart home

The ECHONET Lite Standards published in 2011 were later recommended as a publicly-known standard for home networks by the Japan Smart Community Alliance established by the Ministry of Economy, Trade and Industry (METI). The ECHONET Consortium is working to improve interoperability among multiple vendors by establishing a certification system and standardizing detailed ECHONET Lite usage for each device.

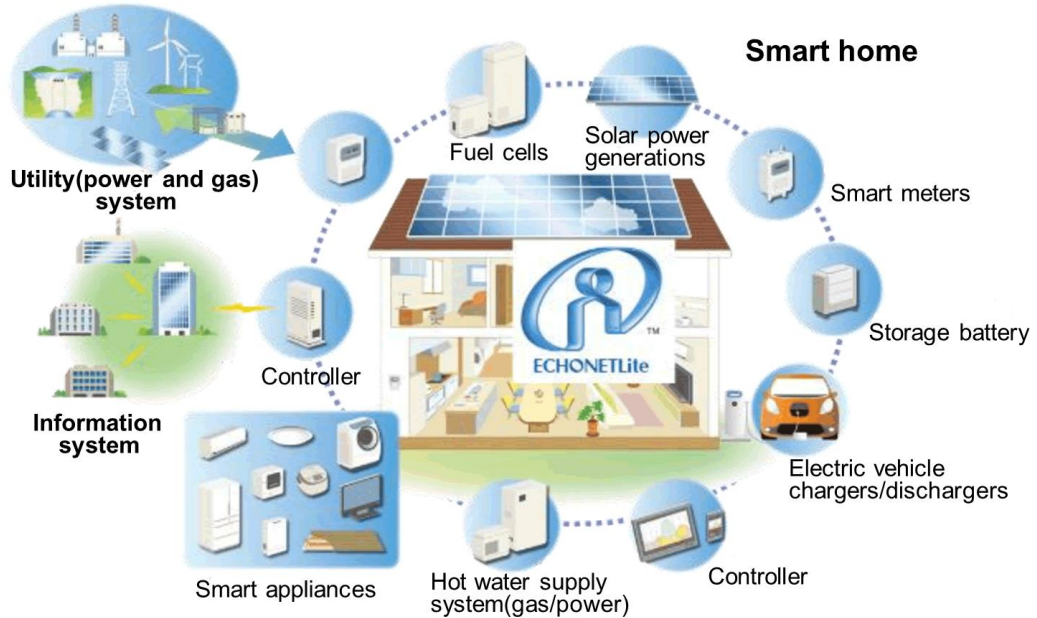

Roadmap for popularization and expansion

		FY2020	FY2021	FY2022	FY2023	FY2024	FY2025	FY2026	FY2030
Environment surrounding ECHONET	Housing policy	Popularization of ZEH in new houses and expansion of IoT in houses, shops, and small and medium-sized buildings							
	Energy policies	Expansion of efforts toward carbon neutrality and enactment and enforcement of the Energy Supply Resilience Act							
		Starting of power distribution business system, specified supply wholesale system, specified measurement system, and power data utilization system				Energy balancing market		Market intro. of next-gen. smart meters	
Digitization policy	Promoting the Digital Garden City Concept and Enhancing Personal Information Protection								
	Spread of cloud services and IoT home appliances, expansion of use of smartphones for digital healthcare, creation of data distribution market								
ECHONET Consortium Master schedule	Basic roadmap	ECHONET Lite dev.:100 M units	Device object definition: 200 models *1					Introduction of home controllers to all households	
	Cyberspace expansion roadmap					Service examples by ECHONET Lite Web API; 50 cases		Covering all households with ECHONET 2.0 services	
		Contribution to the realization of SDGs through ECHONET 2.0							
Promotion activities	Domestic markets	Introduction on the Consortium website and other websites, organization of forums and seminars, promotion at exhibitions							
	Overseas markets	Spread overseas (Asia), promote win-win collaboration activities with other organizations, and PR at overseas exhibitions							
Enhancing standards	Expansion of application of AIF specs and certification test specs, rev. of Detailed Requirements for Device objects (twice/year)								
	▲ AIF specs publication ▲ ECHONET Lite Ver. 1.14 release								
	Formulation and update of ECHONET Lite Web API guidelines								
	▲ API specs section Ver1.10 Device specs Ver1.20				▲ API specs section Ver1.14 Device specs Ver1.41				
	Formulation of cooperation specs between PCHA and CHAdEMO Association				Further expand collaboration with health and healthcare-related businesses and electric vehicle-related businesses				
Release of cooperation specs *2 ▲				Further expansion of cooperation with other organizations					
Promotion of international standardization of ECHONET Lite AIF specifications									
Enhancing certification system	Starting of IoT Master system and test operation of ECHONET 2.0 technical seminar				Study of expansion of authentication system (server, user, web space)				
	Expansion and operation of the certification system								

*1 : Definition in ECHONET Lite and ECHONET Lite Web API, including those through cooperation with other organizations

*2 : ECHONET Consortium- PCHA Guidance on Data Linkages, CHAdEMO-ECHONET Lite Linkage Guidelines

Overview of the ECHONET Lite Standards

ECHONET Lite is a communication specification that enables resource-saving devices (such as sensors, home appliances, and facility-related equipment) to support IoT and realizes energy management service and remote maintenance service. By adopting common specifications for communication specifications and commands for devices, it is possible to build a system in a multi-vendor environment. The following figure shows the structure of ECHONET Lite specifications.

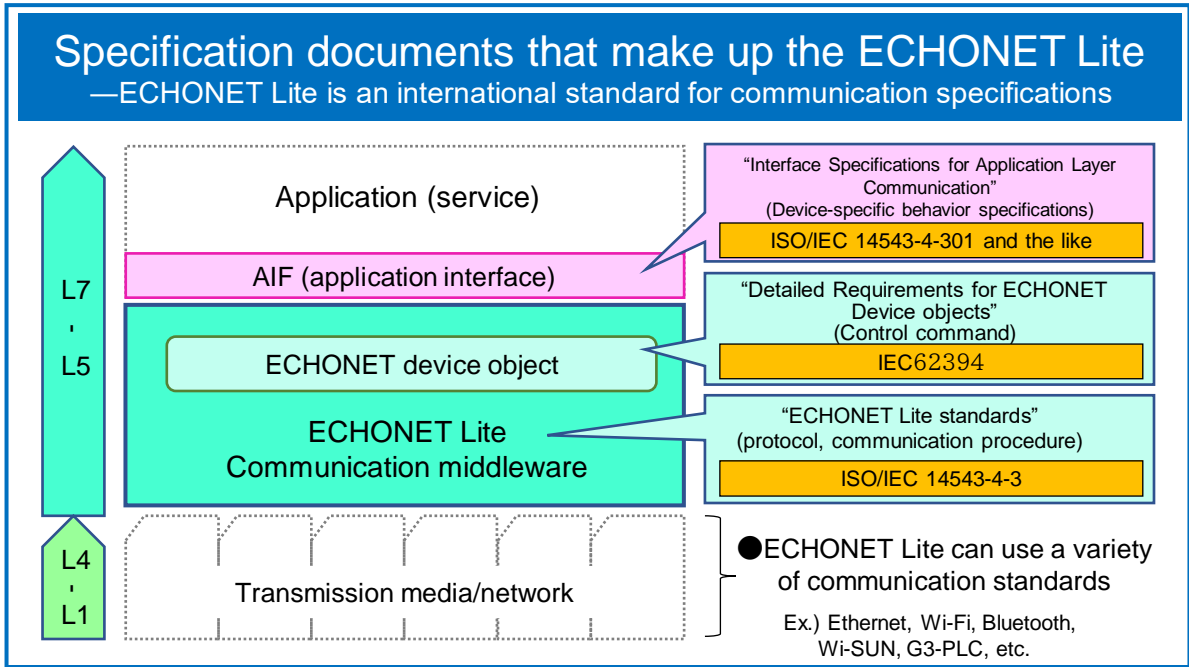

The main features of the ECHONET Lite that realizes IoT for resource-saving equipment and realizes interconnection between multiple vendors are shown below.

(1) Various existing standard transmission media can be used

The scope specified in ECHONET Lite is L5 and higher in the OSI Reference Model and does not depend on lower-layer communication specifications. The communication address specifies recipients by using an IP address or MAC address of transmission media. Therefore, it is possible to select a reasonable transmission media source from the market based on various requirements, such as services and applications.

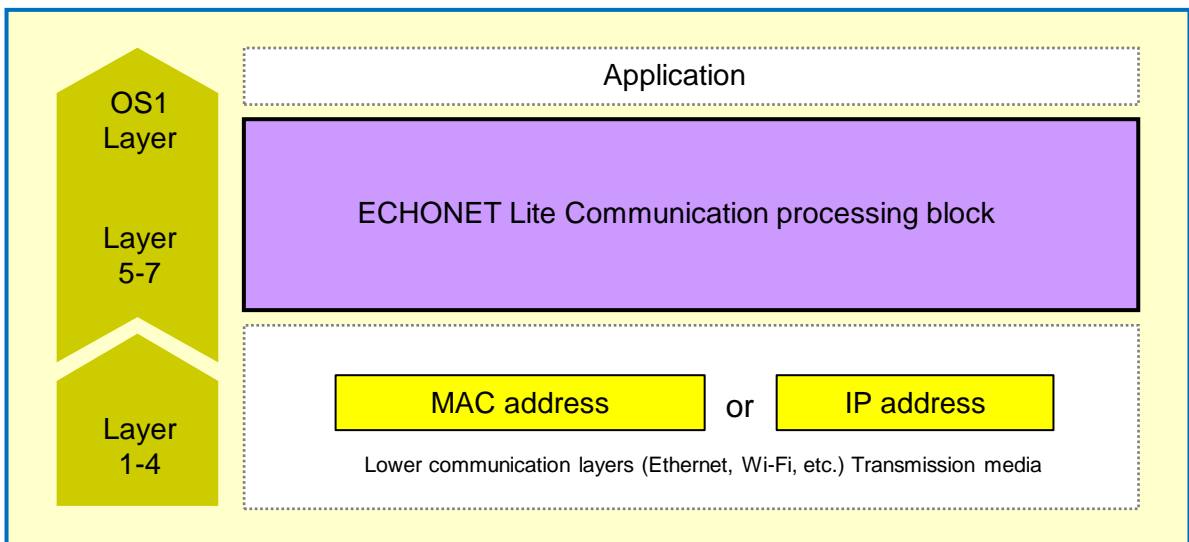

(2) Applicable for a wide range of appliances for homes, small and medium-sized buildings and stores

Since the establishment of the ECHONET Consortium in 1997, we have continuously expanded the control commands. The ECHONET Consortium defines them as device objects by modeling various programs and the data that various devices have.

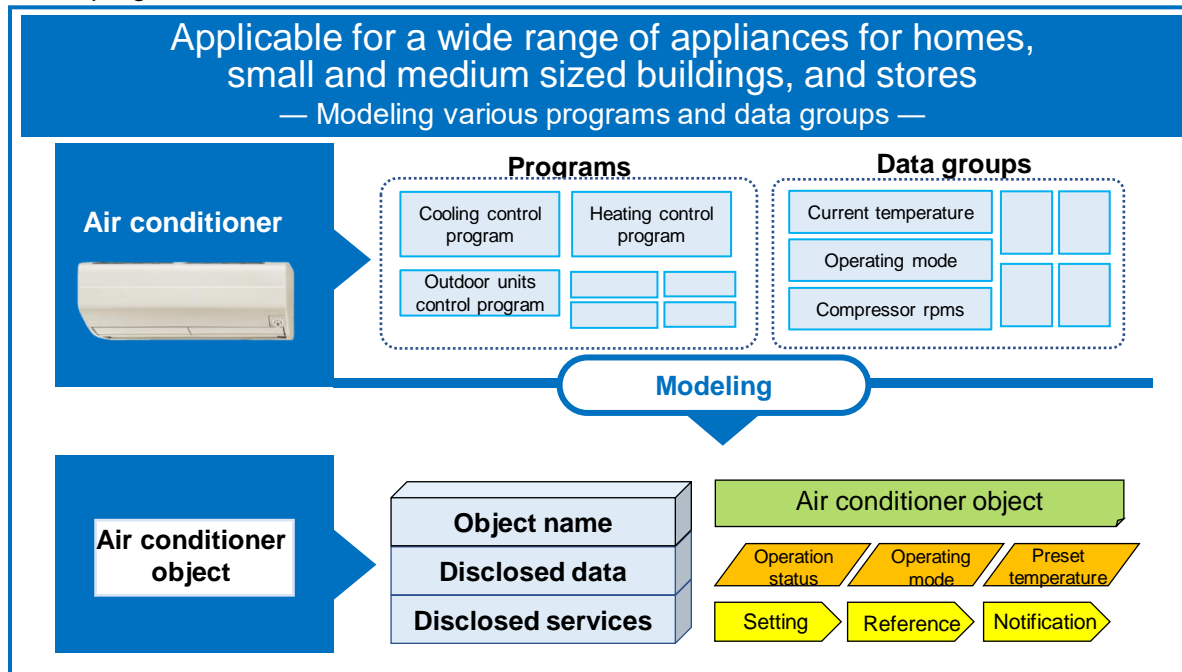

We have defined detailed device objects (control commands) for more than 110 types so far, including sensors, energy-saving devices such as air conditioners and lighting, energy-storing devices such as storage batteries and heat-pump water heaters, energy-generating devices such as solar power generators and fuel cells, measurement devices such as smart meters, and commercial devices such as commercial-use package air conditioners and showcases. Note that the device objects are classified into seven different groups (class groups) according to their use.

Class group code	Class group	Examples
0x00	Sensor-related device class group	Fire sensors, motion detection sensors, temperature sensors, CO2 sensors, current sensors, etc.
0x01	Air conditioner-related device class group	Air conditioners, fans, ventilation fans, air cleaners, heating carpets, oil fan heaters, commercial-use package air conditioners, etc.
0x02	Housing/facilities-related device class group	Electric shades/curtains, water heaters, electronic locks, smart meters, solar power generators, storage batteries, fuel cells, general lightings, single function lightings, emergency lights, lighting systems, expansion lighting system, etc.
0x03	Cooking/Household-related Device Class Group	Microwave oven, dishwashers, dish drying machines, washing machines, clothes drying machines, commercial-use refrigerated display cases, etc.
0x04	Health-related device class group	Scales, body fat analyzers, thermometers, blood pressure monitors, blood glucose meters, etc.
0x05	Management/operation-related device class group	Controllers, switch (HA equipment), etc.
0x06	Audiovisual-related device class group	Television, display, etc.

(3) Further interoperability improvement for key devices

The ECHONET Lite standards have become general-purpose specifications that can be applied to all over 120 types of devices thanks to achieve a high level of interoperability by conducting standard conformity certification tests. The ECHONET Consortium has defined more than ten types of devices as key devices, including home air conditioners, storage batteries, solar power generation, commercial-use package air conditioners, and smart meters (high/low voltage). In order to achieve a higher level of interoperability for these devices, the ECHONET Consortium has formulated the Interface Specifications for Application Layer Communication (AIF specifications) which define the specific usage of ECHONET Lite at the application level of each device. For example, the AIF specifications defines the following items:

- Installed device objects
- Combination of supported properties
- Timeout after sending a request until receiving a response
- Sequence assuming concrete use case

In addition, by conducting standards conformance certification tests for AIF specifications at a third-party testing laboratory certified by the ECHONET Consortium, we are conducting more reliable tests.

(4) Enables linkage with cloud services

It is important to study overall system architecture to study communication specifications. When we formulated the ECHONET Lite communication specifications, we designed an architecture which set controllers or similar devices which have gateway functions between various internet-based services and devices installed at local environment such as ordinary homes. The figure below shows an example system configuration.

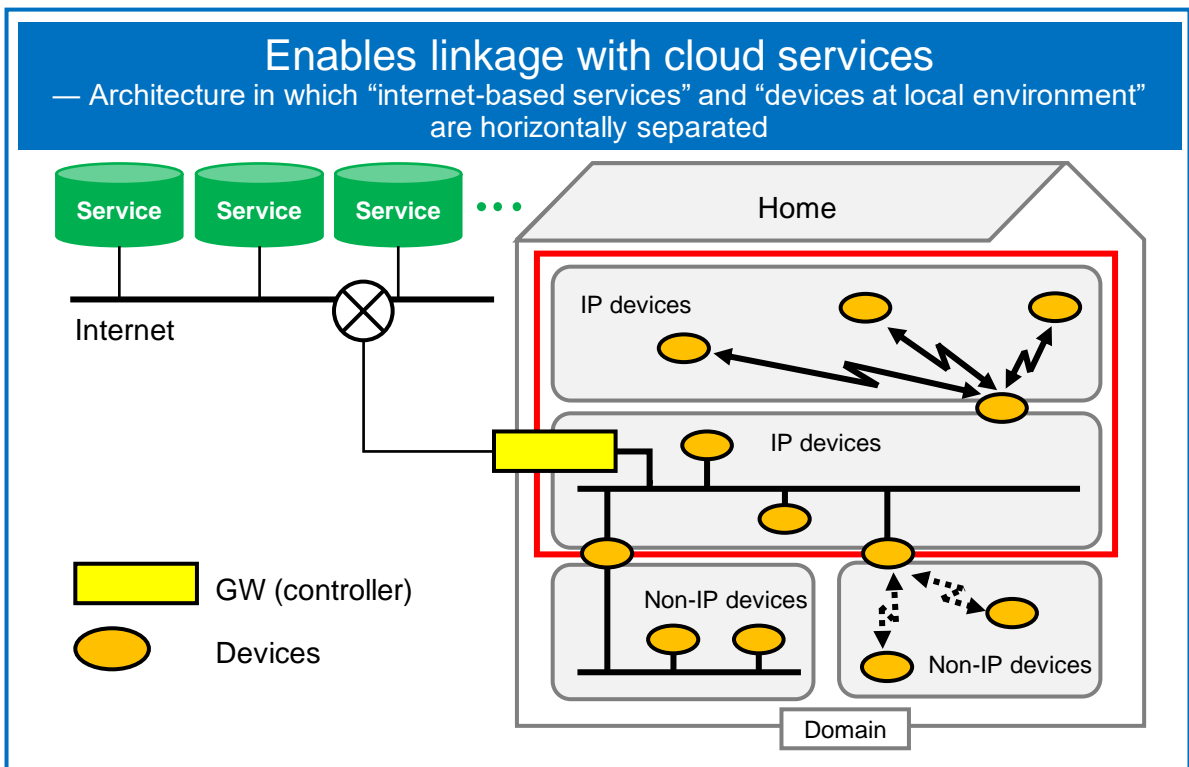

Because the system above can be built, specifications study and development in services and devices can be done respectively and parallelly. This enables us to expect services to be provided not only by device manufacturers but also by various service providers.

ECHONET Lite Web API

As IoT technology evolves, the cloud-based service delivery model is developing. Under these circumstances, it is conceivable that the various services and application development that effectively uses ECHONET Lite devices, which are becoming increasingly popular, will be developed as new businesses. As a measure to boost the number of service providers that provide those businesses, the ECHONET Consortium formulated the ECHONET Lite Web API Guidelines which are common technology for service and application developers.

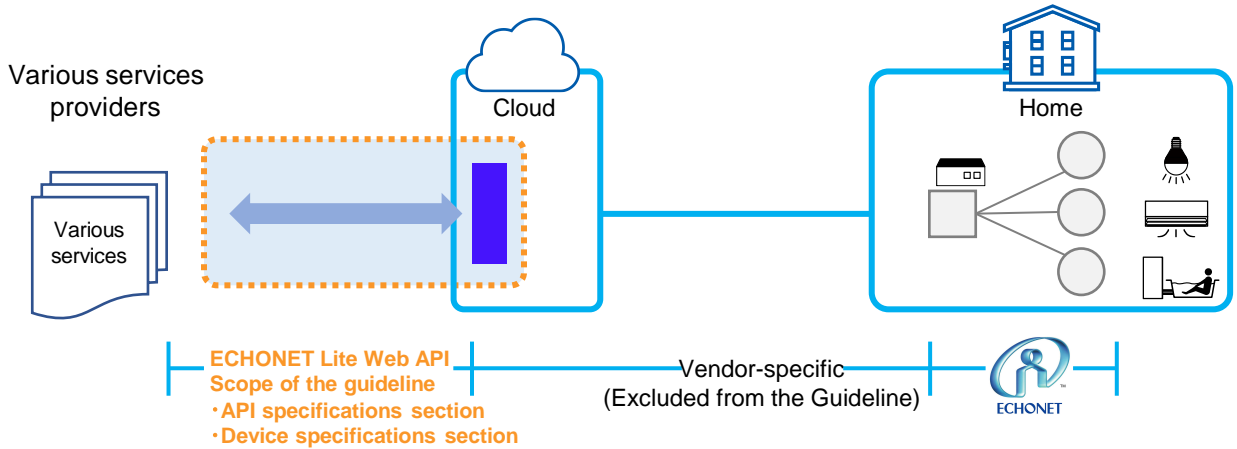

The ECHONET Lite Web API Guidelines are composed of two types of documents: (1) API specifications section that summarizes the definition policies of the Web API models and the mapping policies from ECHONET Lite specifications; and (2) Device specifications section that summarizes the Device Description for each device.

The API specifications section supports: (1) basic use cases including obtaining device lists and obtaining and controlling device status; and (2) application use cases including grouping multiple devices and obtaining historical data. In the Device specifications section, specifications are being developed sequentially, with priority given to (1) AIF devices and (2) ECHONET Lite certified devices.

To conduct operation verification of services compliant with the ECHONET Lite Web API Guidelines, an Experimental Cloud compliant with the guidelines is provided as a free service exclusively for ECHONET Consortium members. The Experimental Cloud grants an account to each applicant so he/she can freely formulate emulation device configurations that is suitable for the services to be developed that are assumed by each user.

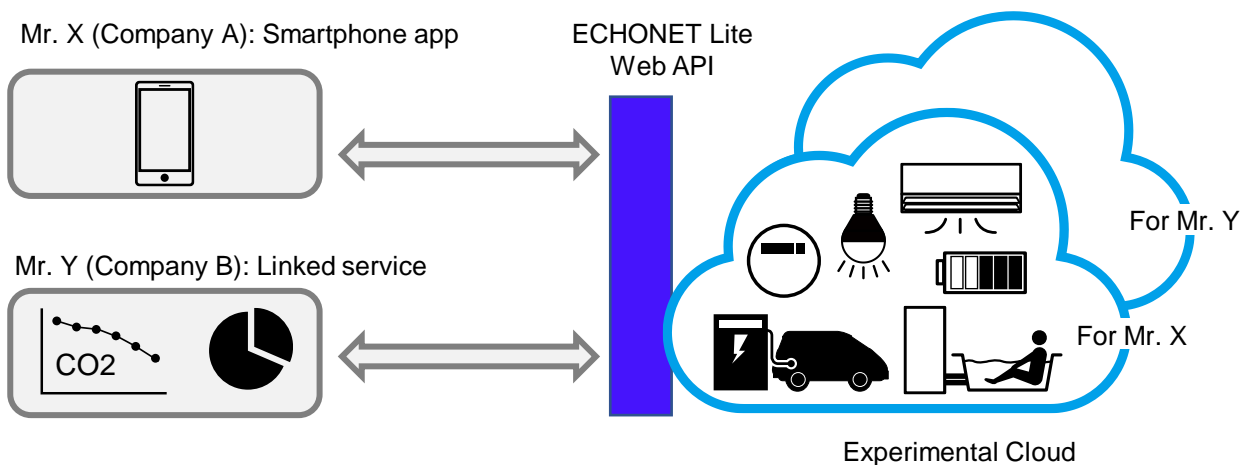

ECHONET 2.0

The world that ECHONET 2.0 is aiming for

Nowadays, various services are increasing in the virtual space on the cloud, and it has become the age that is aiming to realize a super smart society by Cyber Physical System (CPS). As the Internet environment and the society change drastically, ECHONET Consortium set up the “ECHONET 2.0 Strategic Guidelines” in February 2022 to contribute to the realization of SDGs and is strengthening the cooperation with related organizations along with expanding the ECHONET Lite standards and AIF specifications. ECHONET 2.0 aims to contribute to SDGs by creating a wide variety of new services through the development of ECHONET Lite based platforms by expanding the way services are linked in the cloud era.

ECHONET 2.0 aims to expand in two directions. The first one is to expand and enrich the ECHONET Lite standards, which has become popular in homes and lifestyles, to fields other than home appliances and housing equipment. The second one is to create and expand new value by expanding service collaboration on the cloud using ECHONET Lite Web APIs, so that various devices in the home can be connected to all kinds of services in the evolving digital society.

In the evolving digital society, IoT devices will be connected to all kinds of services.

We support service collaboration of IoT devices using **ECHONET Lite Web API**

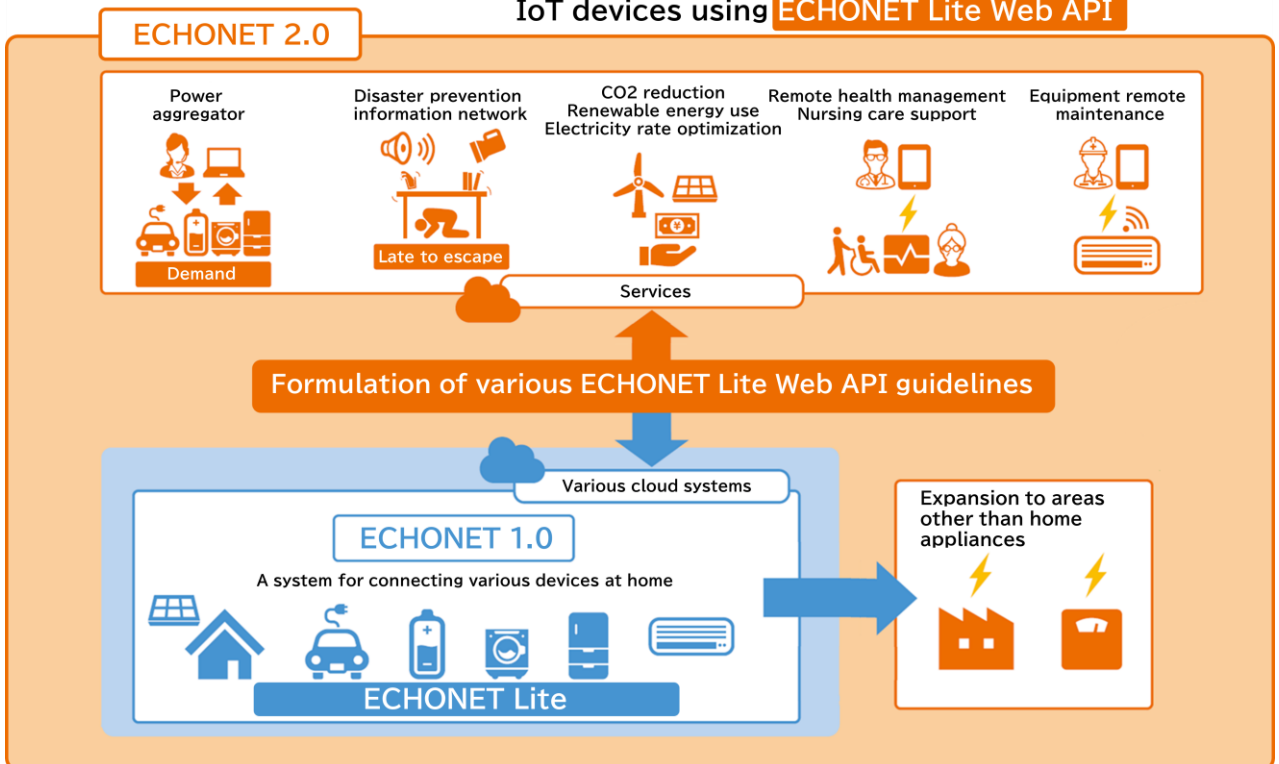

Contribution to the realization of SDGs

Through the formulation of the ECHONET Lite standards, ECHONET Consortium has strengthened the creation of an environment in which the interoperability of resource equipment groups can be verified. In the future, in addition to this, we will work to create an environment where we can certify reliable operators and confirm interconnectable cloud interfaces in cyber space and by realizing the "Orderly collaborative creation space", aim to build a cooperative relationship between service providers and equipment manufacturers and contribute to the realization of SDGs.

Certification system

☐ Purpose and Benefit of Certification

By FY2022, 138.8 million ECHONET Lite devices had been shipped to the market.

Various services, including energy-saving and home security services, can be brought to the real world by combining ECHONET Lite devices to build a home network.

The ECHONET Consortium established a certification system to prove that products are properly compliant with the ECHONET Lite standard and the AIF specifications so that users can feel confident in building a home network.

☐ Overview of Certification system

There are two certification systems established by the ECHONET Consortium: (1) ECHONET Lite Standard Conformance Certification and (2) Application Communication Interface Specification Conformance Certification System (AIF Specification Certification System).

Under the ECHONET Lite Standard Conformance Certification System, an applicant tests its device by itself based on the ECHONET Lite device certification test specification document to confirm that the device conforms to the ECHONET Lite standards and the Detailed Requirements for ECHONET Device objects. Then, the applicant submits the test results to an accredited certification body. The accredited certification body makes a pass or fail judgment of the device based on the test results and grants an ECHONET Lite Standard Certification Registration Certificate if the application meets the criteria.

Under the AIF Specification Certification System, an accredited testing organization tests the device based on the corresponding AIF Specification Certification test specification document, and after the accredited certification body confirms that the device has obtained the ECHONET Lite Standard Conformance Certification, it will make a pass or fail judgment of the device based on the test results of the accredited certification body and grant an AIF Specification Certification Registration Certificate if the equipment meets the criteria. If the applicant obtains AIF Specification Certification for a smart meter, it is necessary to conduct a test to obtain the ECHONET Lite Standard Conformance Certification at an accredited testing organization.

Devices supporting AIF specifications

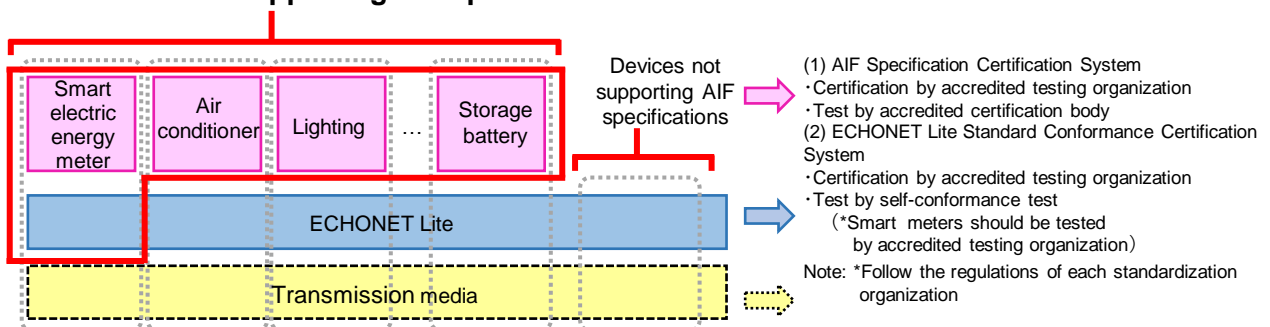

The accredited certification bodies and accredited testing organizations are listed below.

https://echonet.jp/kikaku-ninshou_en/list

Products which obtained ECHONET Lite Standard Conformance Certification and products which obtained AIF Specification certification are published on the ECHONET Consortium website.

Organization and activities

Organization

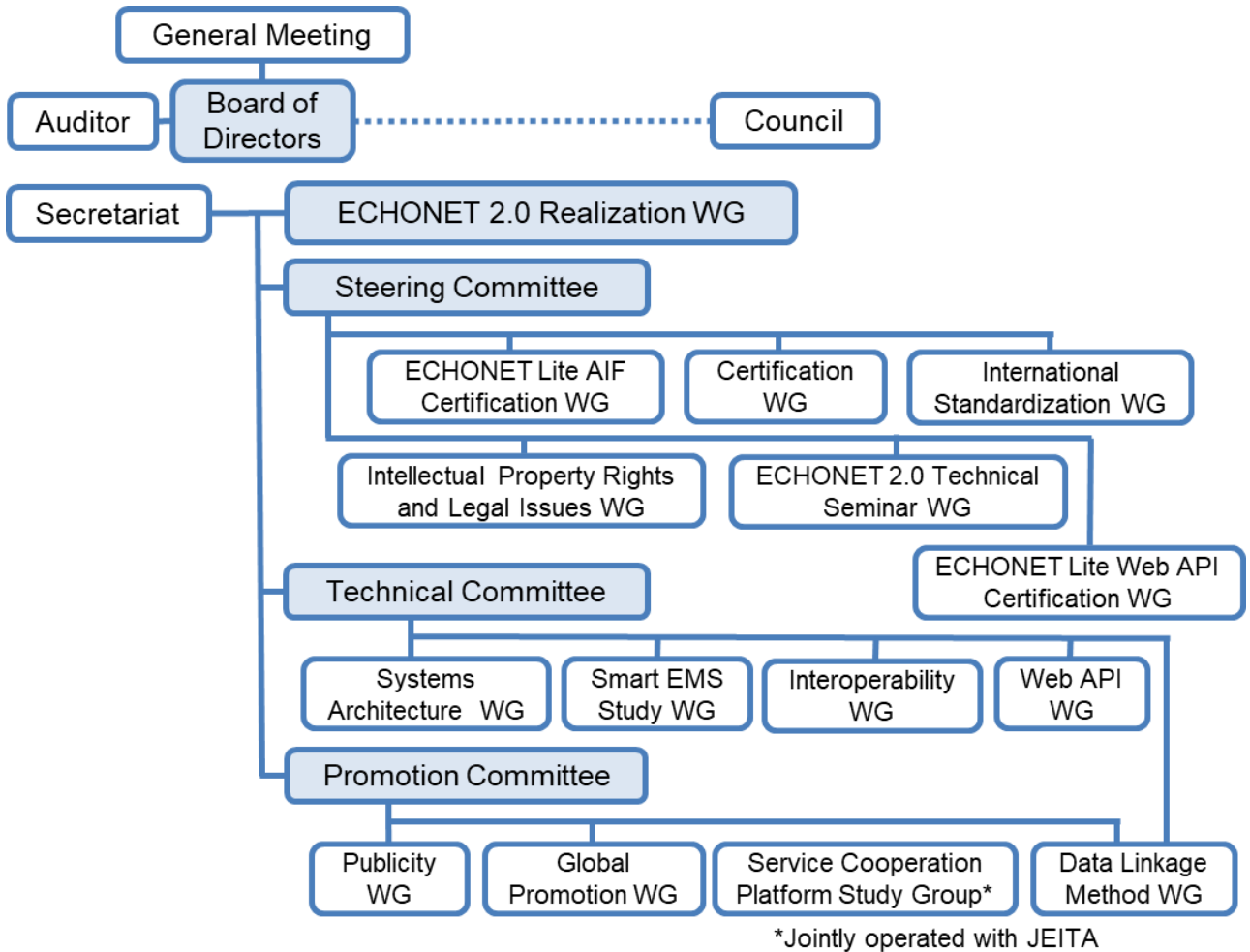

Committees

● Steering Committee

The Steering Committee is engaged in a comprehensive range of activities to ensure the efficient and smooth operation of the ECHONET Consortium as a whole. Its responsibilities include planning, budget management, and administration of general assemblies and forums. It is also responsible for organizing each committee and working group and coordinate overall operation.

● Technical Committee

The Technical Committee is engaged in the development and operation of ECHONET Lite Standards and study of the interoperability including the conduct of Plug Fest as technical activities relating to the basic technology of equipment home network. It also formulates the ECHONET Lite Web API Guidelines, develops and operates the testing environment and tools for service development to follow when services use the ECHONET Lite devices.

● Promotion Committee

The Promotion Committee is engaged in public relations to promote further use of ECHONET Lite and ECHONET Lite Web API developed and standardized by the ECHONET Consortium. It is also involved in the conduct of seminars and symposium, and operation of the exhibiting at exhibitions. It is also working with other standardization organizations and conducting surveys in order to expand the spread of the ECHONET Lite Standards.

Main activities

● Development of the ECHONET Lite Standards

We are continually engaged in the addition and revision of ECHONET device objects and are constantly developing the ECHONET Lite Standards.

● International Standardization Activities

We are working on the international standardization of ECHONET Lite specifications and AIF specifications in international standards organizations such as IEC and ISO/IEC (JTC1). Through these activities, we are increasing international awareness of the ECHONET .



Internal Standardization Activities

● Forum (twice a year)

This is a member only event. We introduce the initiatives and activity status of the ECHONET Consortium and introduce the products of each member company.

● Symposium (once a year)

In order to make non-members aware of the latest information surrounding ECHONET, ECHONET Lite, ECHONET 2.0, and ECHONET Consortium, we will host the forum where we provide the presentations by external experts, people from related ministries and agencies and related companies and organizations as well as the information about our activities.



The 19th ECHONET Forum

● Workshop

We hold the "Home Appliance Open Innovation Workshop" with the aim of increasing the potential of ECHONET Lite through discussions between members and companies that have adopted ECHONET Lite.

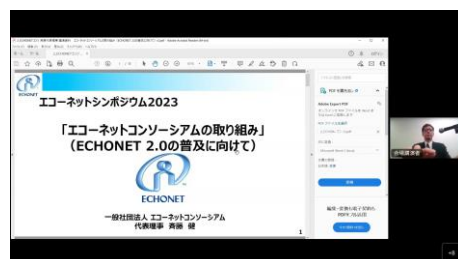

ECHONET Symposium 2023

● Plug Fest

Providing places for interoperability tests with products brought by the member companies aiming the improvement of interoperability of products implementing ECHONET Lite.



Plug Fest

● Exhibitions

Participating in exhibitions in Japan and abroad including CEATEC JAPAN, IFA and CES to promote ECHONET Lite Standards and the member companies' products implementing ECHONET Lite.

● Cooperation with Governmental and Related Bodies

Contributing to the formation of the home network market by participating in government-sponsored commissions and joining the projects with domestic and international home network standardization organizations and related industry organizations.



CEATEC 2023

Membership and qualification System

Main Benefits of membership

Benefit 1	Members can review and comment on the ECHONET standard drafts. Members can also apply to add new device objects or change the properties of existing devices.
Benefit 2	Members can display their products and technologies and introduce them at forums, symposiums, and exhibitions.
Benefit 3	Members can participate in Plug Fest to conduct interoperability tests on their products with products and technologies from other members.
Benefit 4	Members who obtain certification can place the ECHONET™, ECHONET Lite™, ECHONET Ready™ and ECHONET Lite AIF™ trademarks on their products.
Benefit 5	Member can acquire the Member ID/Manufacturer code necessary to develop ECHONET Specification-compliant products.
Benefit 6	Members can use the ECHONET Lite Web API Experiment Cloud Service that supports service development for ECHONET Lite devices.

Membership and qualification

	Managing members* 1	General members* 1	Academic members	ECHONET IoT MASTER qualification
Eligibility	Company recognized as being capable of making a technical contribution to ECHONET	Any company in the world having interest in ECHONET	Educational institution having interest in ECHONET (university laboratory, etc.)	Individuals who have attended ECHONET technical seminars and have been certified
Annual membership fee*2	3,000,000 YEN	300,000 YEN	—	—
Device object proposals	○	○	○*3	○*3
Approval of final specification (voting right)	○	—	—	—
Reviewing of and comment on the specification drafts	○	○	○	—
Viewing of certification specifications	○	○	—*4	—*4
Participation in General Meetings	○	○	—	—
Participation in Board Meetings	○	—	—	—
Participation in Working Groups	○	○*3	—	○*3
Participation in Forums	○	○	○	○
Participation in Plug Fests (ECHONET Lite)	○	○	○	—
Use of trademarks	○	○	○	○
Member ID/Manufacturer code	○	○	—	—
Viewing of members-only website	○	○	—*4	—*4
Subscription of newsletters	○	○	○	○
Use of certification tools	○	○	—	—
Use of ECHONET Lite Web API experimental cloud	○	○	○	○
Join the community site*5	○	○	○	○

*1: Managing members and General members can assign affiliated companies as associate members.

Annual membership fee for associate member is free and membership rights are the same as a general member.

*2: Annual membership fees are applied to all areas of the ECHONET Consortium's operation and are excluded from taxation.

*3: Members can participate in proposals and WGs at the request of the upper committee.

*4: Necessary materials and information are provided by the ECHONET Consortium based on requests from the members.

*5: A site for posting use cases, questions and answers, etc. for the purpose of learning support for ECHONET Lite.

How to apply for membership

Membership applications are accepted through the following website:

https://echonet.jp/admission_en/



The ECHONET logo represents people as the central player of ECHONET surrounded by systems and the environment. Drawing everything with a single line is symbolic of the cohabitation of people and systems. Blue represents the color of the sea which nurtures life, the color of a clear sky spreading toward the future, and the color of a clean environment which is the target of ECHONET. The Logo will be marked on home appliances which meet the ECHONET Specification.

ECHONET™ **エコ-ネット™** **ECHONETLite™** **ECHONETReady™**

ECHONETLiteAIF™ and the left logo are the registered trademark of ECHONET Consortium.

ECHONET Consortium

ECHONET Consortium is an organization that promotes Communication protocol “ECHONET Lite” for home appliances and housing facilities, which are essential elements of smart homes, to cooperate with each other.

We are standardizing the ECHONET Lite and promoting the spread of smart homes with support for commercialization of devices which support the ECHONET Lite standards and cooperation with related industries.

In addition to the ECHONET Lite standards, we also promote formulation of AIF specifications that regulate the behavior of devices and “ECHONET 2.0” to contribute to the realization of a prosperous and sustainable society “Society 5.0” by creating new added value.

ECHONET Consortium has about 260 managing and general members, their associate members, and academic members participated from the home appliances, electricity, electronics, energy, residential, and IT industries, as well as from academic and research fields. Its managing members are Mitsubishi Electric Corporation, Panasonic Holdings Corporation, Sharp Corporation, Tokyo Electric Power Company Holdings, Inc., and Toshiba Corporation.

ECHONET Consortium Secretariat

Shimbashi TS Bldg. 4F

1-22-5 Nishi-Shimbashi, Minato-Ku, Tokyo 105-0003 JAPAN

TEL: 03-6205-4142 FAX: 03-6205-4143

Inquiry form: https://echonet.jp/contact_en/

E-mail: info@echonet.jp

Website URL: <https://echonet.jp/english/>

